

Installation Instructions

Modular
Soap
Dispenser

1A

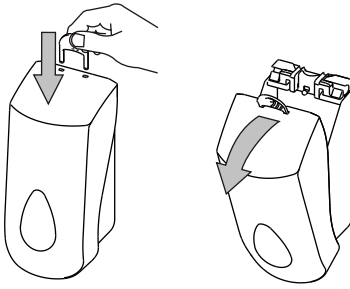

1B

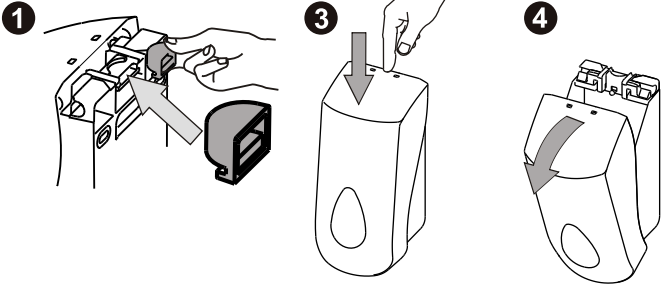

2A

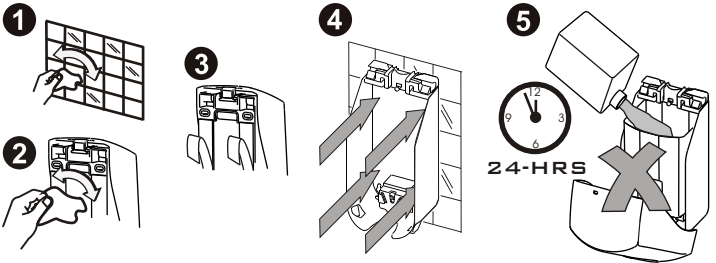

2B

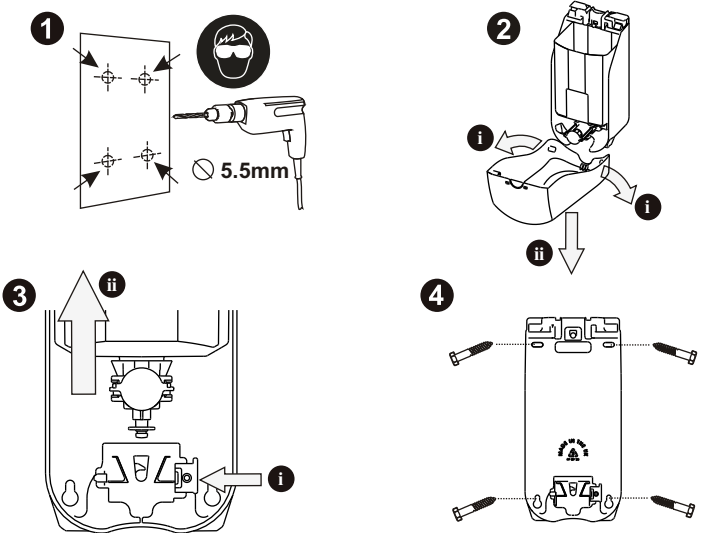



User Instructions

Modular Soap Dispenser

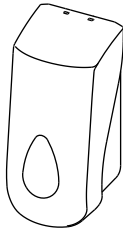

3A



1

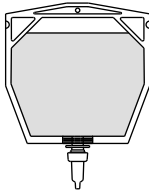

2

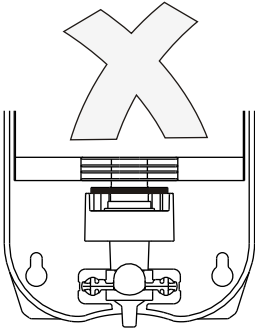
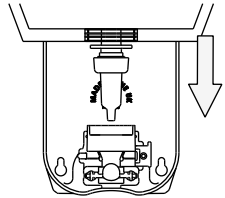

3

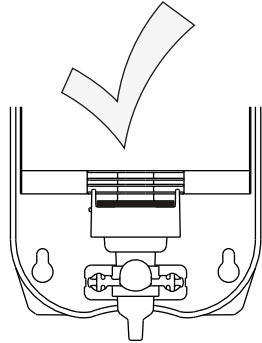

4

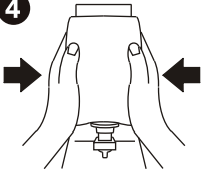

5

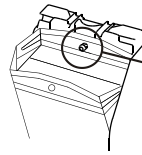
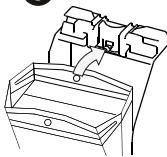

6

